

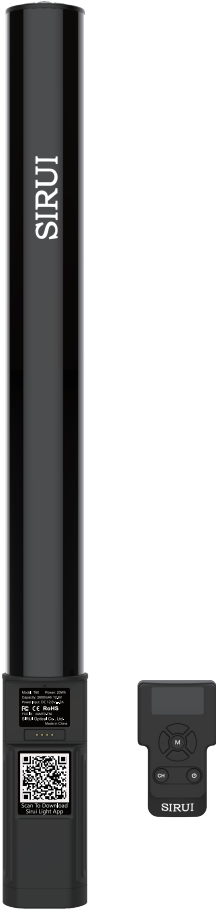

User Guide

Duken T60 Telescopic RGB LED Tube Light



Forward

This RGB LED Tube Light T60 is a telescopic RGB light with multicolor, dual color temperature and light effects mode. Suitable for almost all shooting occasions e.g. live, camping, portrait shooting, make up, video, wedding, children photography, etc., it's portable and easy to operate.

Features

- (1) Fashionable in appearance, intuitive in operation and portable in carrying.
- (2) Freely switch among LED CCT mode, RGB mode and 14 special effects mode.
- (3) Adjust color temperature, light brightness, hue and color saturation easily.
- (4) 20 sets of light parameters can be saved for direct use next time.
- (5) Blink and change colors with the rhythm of music.
- (6) Remote control by smartphone APP/2.4G wireless.
- (7) With built-in lithium battery, it can be charged through DC power jack.
- (8) Use in combination to make more creative light groups.

What's in the Box

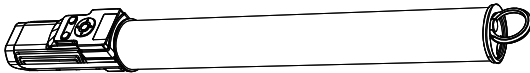

Body *1 (Remote Control*1)

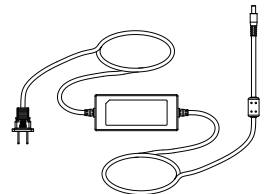

Adapter *1 (3.2m Cable *1)

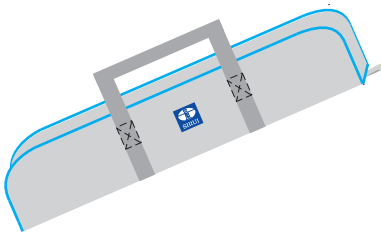

Carry Bag *1



Manual *1



Mini Tripod*1

Names of Parts

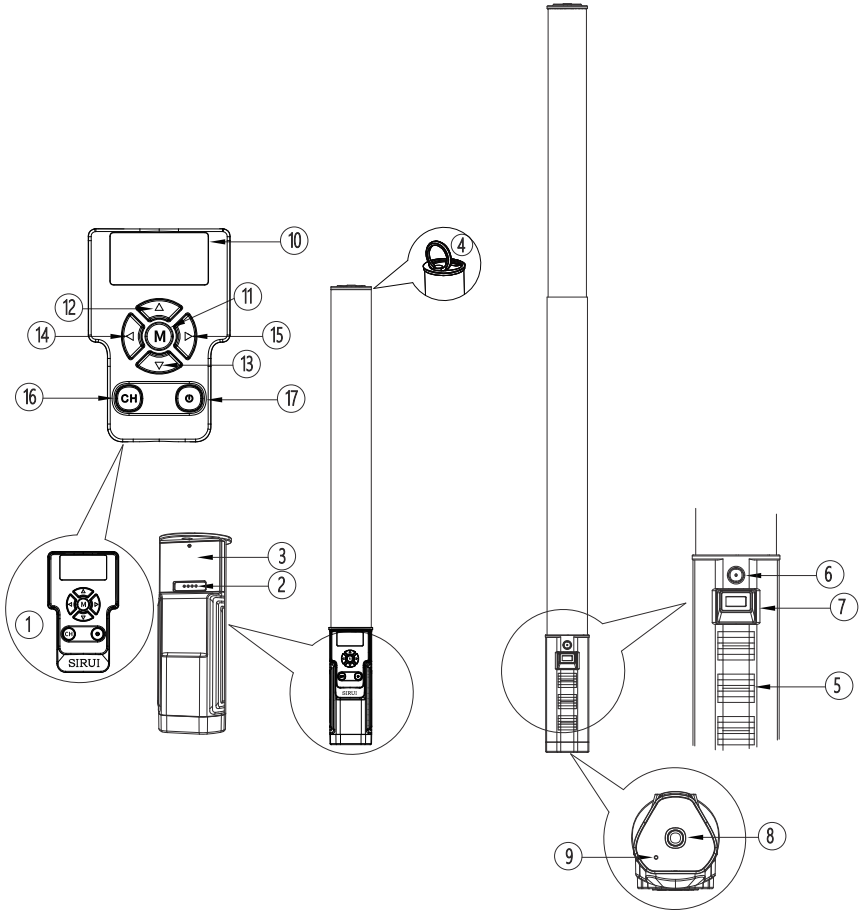

1	Remote Control		10	Display Screen
2	Remote Control Contact		11	Mode Button
3	Slot		12	Up Button
4	Pull-Tab		13	Down Button
5	Grip		14	Left Button
6	DC Power Jack		15	Right Button
7	Power Switch		16	Channel Switch Button
8	1/4" Screw Hole		17	Remote Control Power Switch
9	Soundhole Pickup			

Battery Management

1、Charge

It is recommended to use the provided DC power adapter to fully charge the product before use. It takes about 1.5h to charge the video light. While charging, the power adapter displays a red light to indicate that it is charging, and a green light to indicate that it is fully charged. (Note: Please use recommended adapters for charging, use of other power adapters may void the warranty).

2、Power Supply

There is a built-in lithium battery in the video light, which supports a 2-hour runtime at full power when fully charged. Connect the video light to the DC power adapter for long-time working.

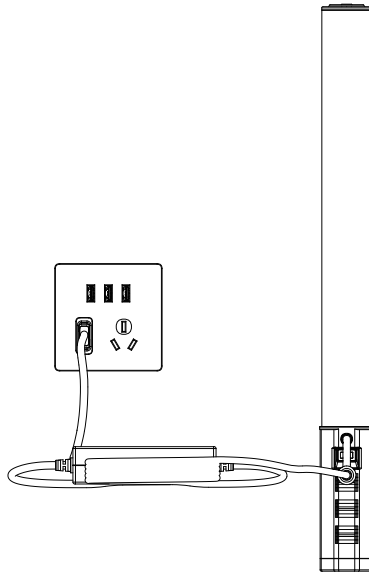

1、 Operation

1.1 Power Switch

Use the power switch to control the on or off of the RGB tube light.

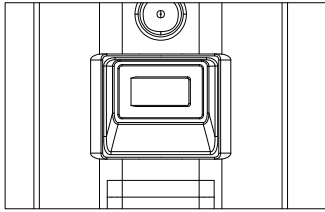

1.2 Turn on/off the remote control and match the channel.

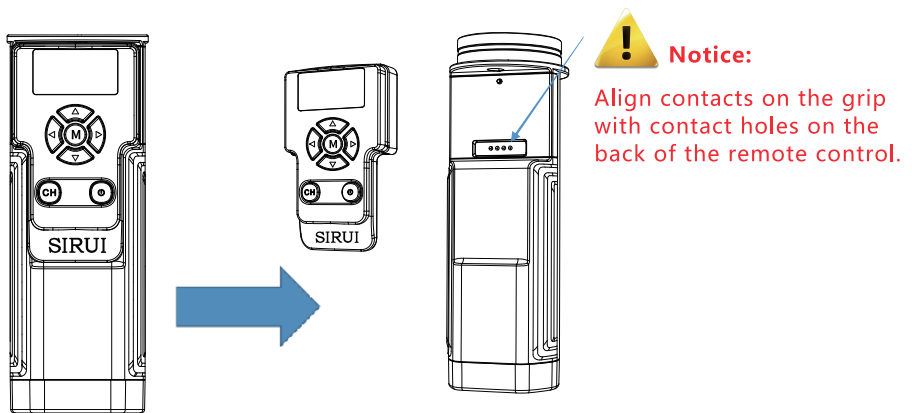

- 1.2.1 Press and hold the power button on the remote control for 2s to turn on/off the remote control.
- 1.2.2 Put the remote control into the slot, and the channel of the video light will synchronize with that of the remote control.
- 1.2.3 After matching, single press the remote control power button to turn on/off the light (Note: remote control power button is for temporary use only. Please turn off the remote control if you want to turn off the light for a long time).
- 1.2.4 The remote control can either be put into the slot or be removed to control the light remotely.

1.3 Telescopic Tube Light

- 1.3.1 Extension: Hold the grip with your left hand, and pull the pull-tab on the upper end of the light with your right. The light will not light up until it is pulled to the end.
- 1.3.2 Retraction: Hold the grip with your left hand, and press down the light from the upper end with your right. The retracted tube will automatically go out.

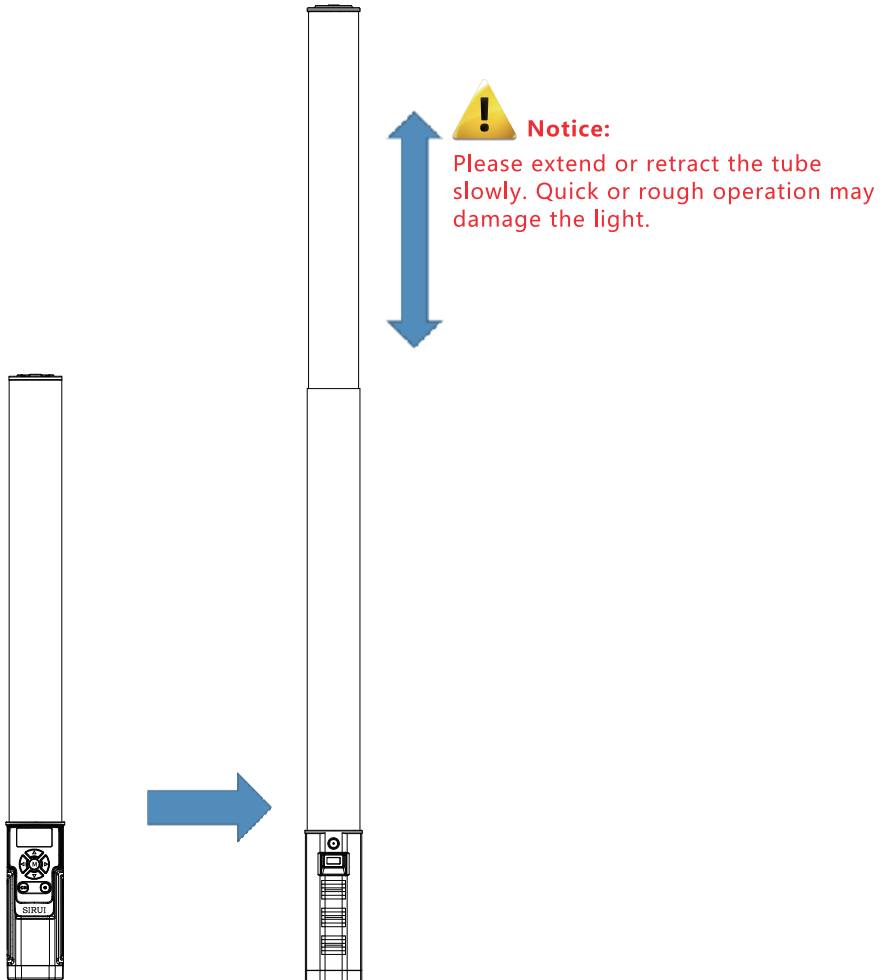

1.4 Remote Control

Mode Selection: CCT Mode/ Colorful Mode/ Light Effects Mode

Tap the M button to switch among different modes:

CCT means bi-color mode

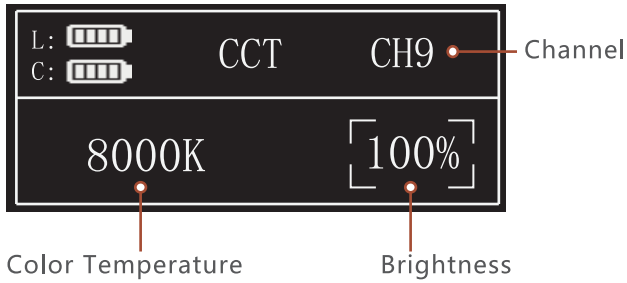

HSI means colorful mode

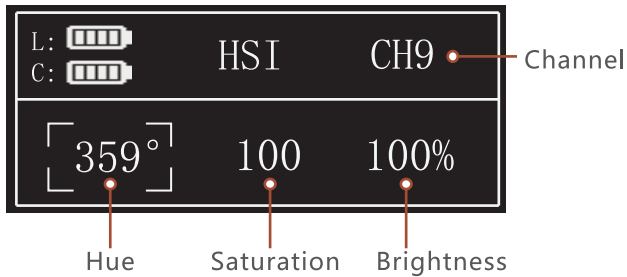

FX means light effects mode, and icons will be displayed.

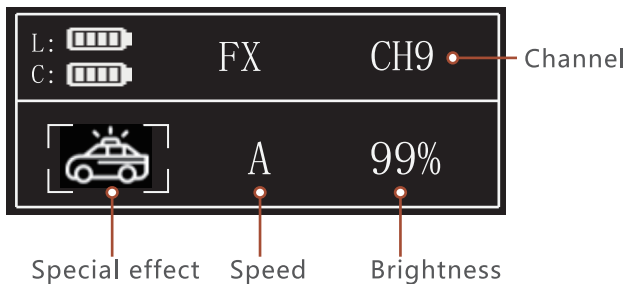

2、Modes

2.1、CCT Mode

- 2.1.1 Tap the Left/Right Button to choose the value (CCT or INT) to be adjusted.
- 2.1.2 Color temperature adjustment: press the Up Button to increase the color temperature value and the Down Button to decrease. Tap the button once and the color temperature value will changes in 50K. Long press the button to adjust the value from 2500K to 8000K quickly.
- 2.1.3 Brightness adjustment: press the Up Button to increase the brightness value and the Down Button to decrease. Tap the button once and the color temperature value will changes in 1%. Long press the button to adjust the value from 0% to 100% quickly.
- 2.1.4 CCT storage: long press the M Button for two seconds to enter the CCT Save/Read interface.

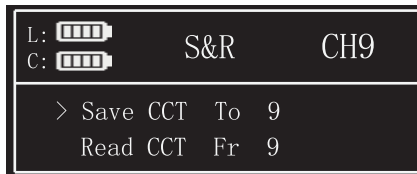

- 2.1.4.1 Press Up/Down Button to select Save/Read.
- 2.1.4.2 Press the Left/Right Button to select the corresponding serial number to Save/Read.
- 2.1.4.3 Press the M Button to save a parameter after you choose "Save" (10 sets of parameters can be saved). If you select the serial number of an existing parameter during storage, the parameter will be overwritten. Press the M Button to read a specific parameter after you choose "Read".

2.2、Colorful Mode

- 2.2.1 Tap the Left/Right Button to choose the value (HUE, SAT, INT) to be adjusted.
- 2.2.2 Hue adjustment: press the Up Button to increase the hue value and the Down Button to decrease. Tap the button once and the hue value will changes in 1°. Long press the button to adjust the value from 0° to 359° quickly.
- 2.2.3 Saturation adjustment: press the Up Button to increase the saturation value and the Down Button to decrease. Tap the button once and the saturation value will changes in 1. Long press the button to adjust the value from 0 to 100 quickly.
- 2.2.4 Brightness adjustment: press the Up Button to increase the brightness value and the Down Button to decrease. Tap the button once and the brightness value will changes in 1%. Long press the button to adjust the value from 0% to 100% quickly.
- 2.2.5 HSI storage: long press the M button for two seconds to enter the HSI Save/Read interface.



- 2.2.5.1 Press Up/Down Button to select Save/Read.
- 2.2.5.2 Press the Left/Right Button to select the corresponding serial number to Save/Read.
- 2.2.5.3 Press the M Button to save a parameter after you choose "Save" (10 sets of parameters can be saved). If you select the serial number of an existing parameter during storage, the parameter will be overwritten. Press the M Button to read a specific parameter after you choose "Read".

2.3、 Light Effects Mode

- 2.3.1 Tap the Left/Right Button to choose from EFFECT, Gear and INT.
- 2.3.2 Light Effects: press the Up/Down Button to choose from the 14 effects.
- 2.3.3 Gear adjustment: press the Up/Down Button to shift from three gears (A, B, C).
- 2.3.4 INT adjustment: press the Up Button to increase the INT and the Down Button to decrease. Tap the button once and the INT will changes in 1%. Long press the button to adjust the value from 0% to 100% quickly.
- 2.3.5 There' re 39 kinds of situational special effects mode which are divided into 14 categories for your choice:

No.	Display	Light Effects	Display A	Display B	Display C
1		RGB Recycle	Slow	Medium	Fast
2		Flash	Flash	Fashion Show	Paparazzi
3		Disco	Birthday Party	KTV	Disco
4		Lightning	Intermittent	Frequent	continuous
5		Fault light	Intermittent	Frequent	continuous
6		TV	Slow	Medium	Fast
7		Candle	Intermittent	Frequent	continuous
8		Fire	Log Fire	Bonfire	Fire
9		Firework	Brief	Continuous	Display
10		Police Car	Fast	Medium	Slow
11		Fire Truck	Fast	Medium	Slow
12		Ambulance	Fast	Medium	Slow
13		Music	Music1	Music2	
14	SOS	SOS			

2.4、 Channel Settings

2.4.1 Put the remote control into the card slot, and the channel of the video light will synchronize with that of the remote control.

2.4.2 Short press CH button to switch to your desired channel. When the controller is taken off, the channel of the video light remains consistent with that of the controller. For example, if the channel of the controller is switched to CH5, the channel of the video light will be the same. To switch the channel of the video light, the remote control should be inserted into the card slot first.

2.4.3 If you own several T60 RGB lights, you can group control their brightness and switches (groups at most are 10).

2.4.4 The LCD screen can display ten channels (CH0 to CH9), and you can switch channels by short pressing the CH button.

3、 Battery Level

3.1 Turn on both the video light and the remote control. Insert the remote control into the slot (the video light will charge the remote control), L and C on the LCD display indicate the battery level of the video light and remote control respectively (turn on the video light before charging the remote control).

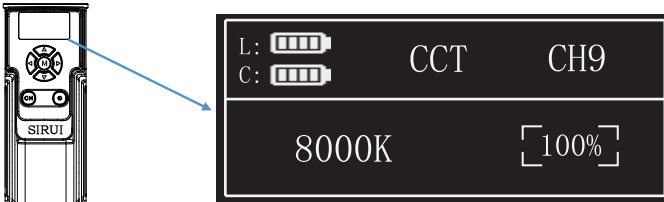

When the remote control is turned off for charging.



3.2 Remove the remote control. The LCD display indicates the battery level of the remote control itself (C).

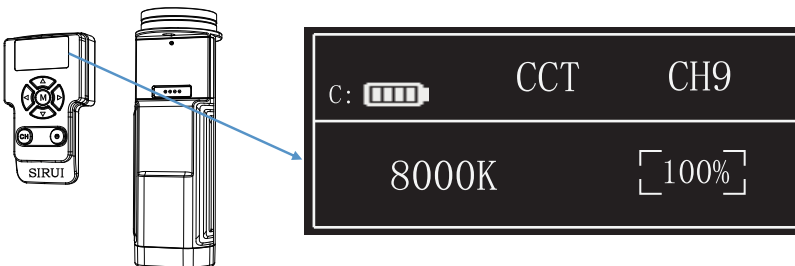

4、 Connect with Smartphone APP

Scan the QR code to download the "SIRUI Light" APP.



For more smartphone APP operations, please click "help" in APP to gain detailed guidance.

5、 Installation and Fixing

You can install the video light as shown in the figure below.
Fasten the video light to the tripod directly.

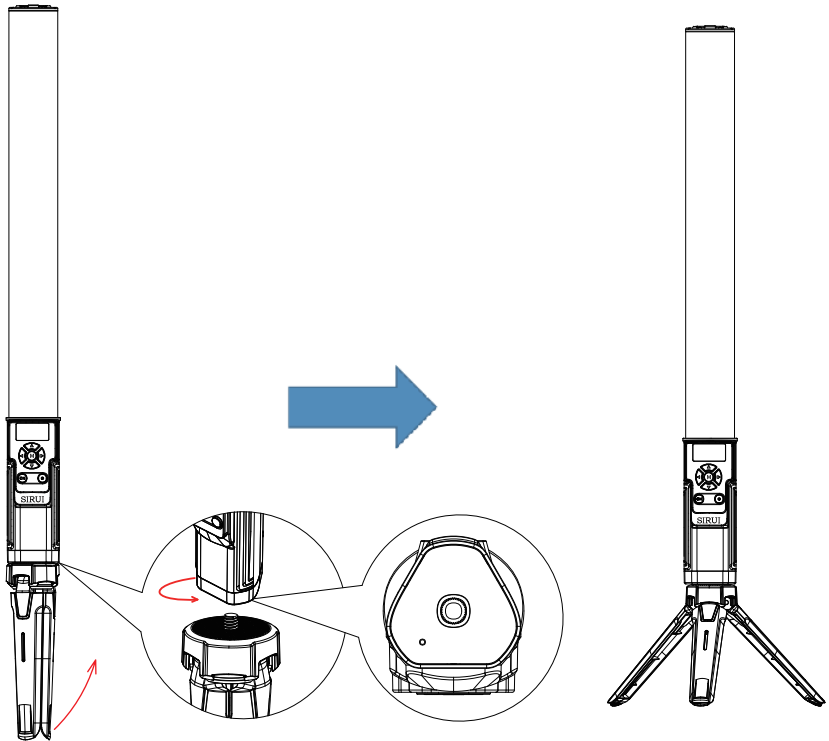

Technical Data

Model	T60
Dimensions	Retracted : $\varphi 42 \times 455 \text{mm}$; Extended : $\varphi 42 \times 740 \text{mm}$
Weight	Approx. 658g
Built-in Lithium Battery	3*2600mAh 3.7V
Adapter	12.6V 2A
Charge Time	1.5H
Charging Port	DC Power Jack
Power	Max. 20W
Color Temperature Range	2500K~8000K
RGB Color Gamut	0-359°
Light Effects	14 Categories
Illuminance	0.5m 1000lux
Illumination Distance	3-5m
TLCI	97
CRI	97
Brightness Range	0%-100%
Duration(continuous output in 100% full power)	2H
Operation Temperature	-10°C-45°C
Control Method	Smartphone APP/2.4G Wireless
Bluetooth Wireless Control Distance	15m
Remote Control Distance	15m
Channel	10

* Product design and specifications are subject to change without notice.

Battery

1. This video light has a built-in 2600mAh lithium battery, which is non-removable.
2. The battery is reliable. The inner circuit is against overcharge, overdischarge, overcurrent and short circuit.
3. Use the provided adapter to charge the battery. The indicator on the adapter turns from red to green means the battery is fully charged. Using while charging is allowed.

Cautions

1. Do not charge the battery for over 24 hours.
2. Store in dry, cool, ventilated places.
3. Do not put the battery near the fire.
4. Please charge the battery to 70% before setting it aside for a long time.
5. If the battery has ceased using for over 3 months, please make a full recharge.
6. It is normal that the battery performance degrades after using for a certain period of time.
7. Dead batteries should be disposed according to local regulations.
8. Use recommended adapters to charge the battery. Use of other adapters may void the warranty.

Maintenance

1. Shut down the device immediately should there any abnormal occur.
2. Avoid sudden impacts and the product should be dedusted regularly.
3. It is normal for the light beads to be warm when in use.
4. Maintenance of the light must be performed by authorized maintenance department which can provide original accessories.
5. This product, except consumables, has a one-year warranty. Lithium battery has six months warranty.
6. Unauthorized service will void the warranty.
7. If the product has failures or is wet, do not use it until it is repaired by professionals.
8. Specifications or designs are subject to change without prior notice.

Warnings

1. As this product is not waterproof, please take waterproof measures in rainy or damp environment.
2. Please keep the product dry. Do not touch the product with wet hands, immerse it in water or expose it to rain.
3. Do not use this product in the presence of flammable gases, chemicals and other similar materials. In certain circumstances, these materials may be sensitive to the strong light emitting from this product and fire or electromagnetic interference may result.
4. As this product has a built-in lithium battery, do not disassemble, impact, squeeze it or put it into fire. If serious bulge occurs, please stop using it.
5. Do not place the product in an environment where the temperature exceeds 50°C. Please charge the product with included adapter and operate it properly within the defined voltage and working temperature.
6. Please don't look directly at the light when it is working.



使用手册

杜肯T60伸缩式RGB LED管灯

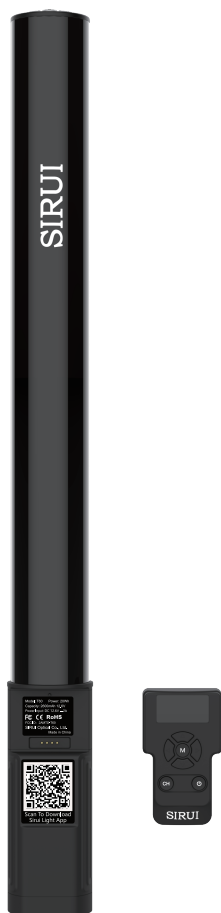

前言

伸缩式RGB LED管灯T60，伸缩设计可变长度，有双色温模式、RGB彩光模式、情景特效模式，可以调节对应参数数值获得相应光效。适用相机、手机、运动相机等设备，应用于人像、婚纱摄影、静物拍摄、产品摄影、直播、视频和微电影等场景。可以在有限空间内补光、轻松动感补光等。多种遥控方式，操作便捷。

主要特点

- (1) 创意伸缩设计，外观时尚，操作简单，轻巧便携。
- (2) 便捷切换LED双色温模式、RGB彩光模式和14种情景特效模式。
- (3) 自由调节色温、色相、色彩饱和度、亮度。
- (4) 灯光参数记忆功能，可以保存20组场景参数，方便下次直接使用。
- (5) 跟随音乐跳动并变换颜色，营造多彩氛围。
- (6) 多灯联控，手机APP、2.4G无线遥控器控制。
- (7) 内置锂电池，DC接口充电。
- (8) 随心组合，打造各类创意灯光造型组。

包装清单



灯体* 1 (含遥控器 * 1)

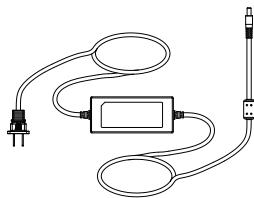

适配器 * 1 (含3.2m电源线) * 1

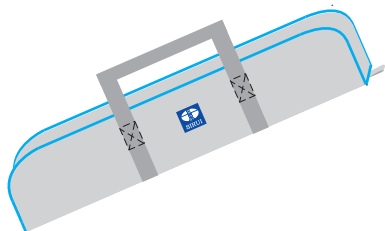

便携包*1



保修卡*1



脚架*1

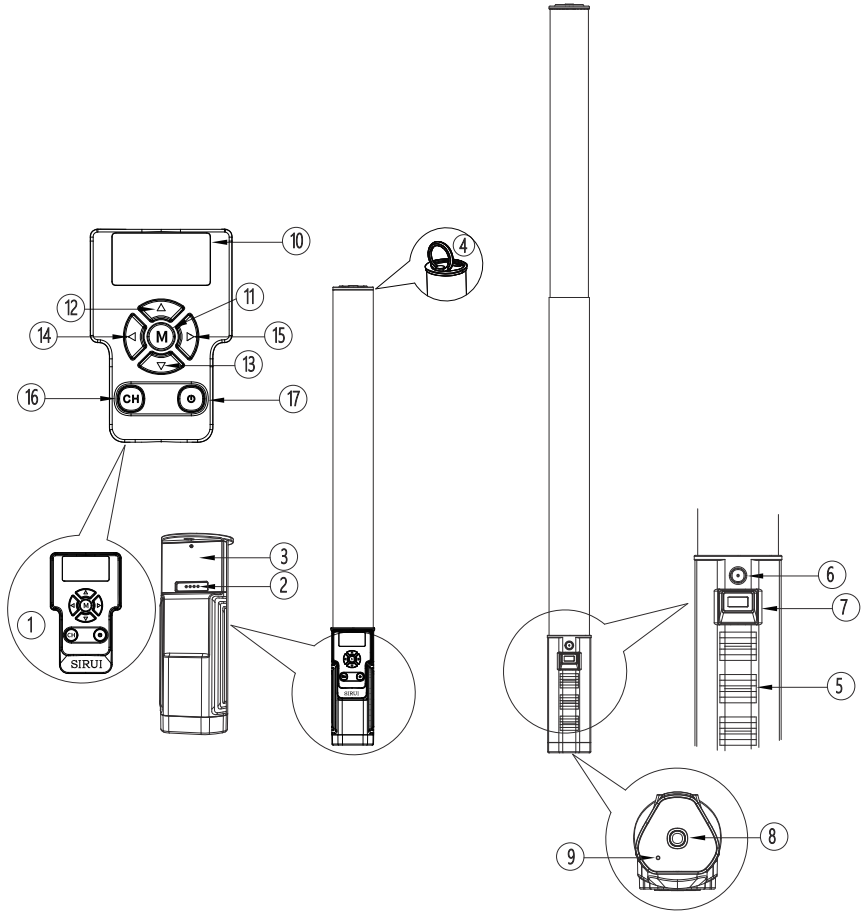

1	遥控器		10	显示屏
2	触点		11	模式键
3	卡槽		12	上键
4	拉环		13	下键
5	手柄		14	左键
6	DC电源口		15	右键
7	电源开关		16	频道切换按键
8	1/4螺丝孔		17	遥控器开关键
9	拾音孔			

1、充电

使用前建议使用自带DC电源适配器充满电，充电时间约1.5h。充电时电源适配器显示红灯表示正在充电，显示绿灯表示充满。（注：请使用配套适配器进行充电，其他规格有可能导致硬件损坏。如使用其他电源适配器造成的产品故障，不予保修）

2、供电

内置锂电池，充满一次电 8000K 100%亮度持续常亮约2h。也可以使用自带DC电源适配器连接电源使用，以获得灯光的长时间工作。

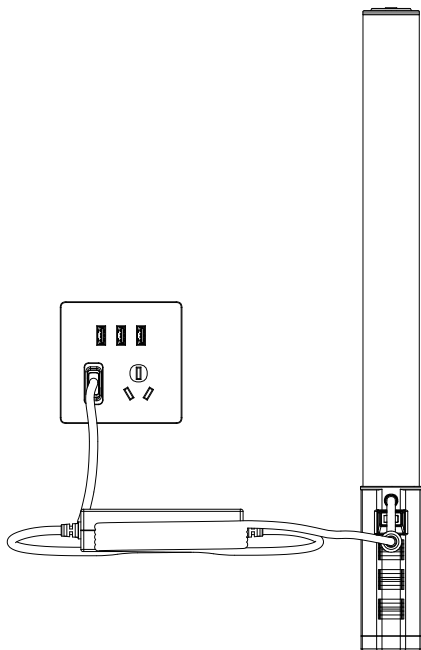

1、操作说明

1.1 开关机

使用电源开关控制灯光电源打开和关闭。

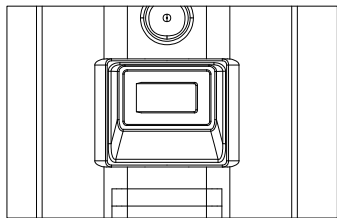

1.2 打开/关闭遥控器和匹配频道

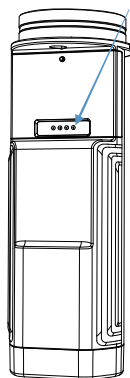
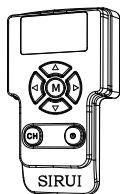
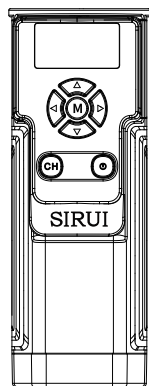

警示

遥控器放入灯体时，要居中放置使4个触孔与灯体的pin针一一对应，否则会引起程序错误。

1.2.1 长按2S遥控器开关键开/关遥控器。

1.2.2 将遥控器插入补光灯卡槽，遥控器自动和补光灯匹配频道（匹配和屏幕显示的频道按照补光灯设定的频道号）。

1.2.3 匹配好的遥控器单按可以控制灯光打开/关闭（说明：遥控器开关灯是软件临时关灯使用，如果要长时间关灯，请关闭电源开关，否则会影响电池寿命）。

1.2.4 遥控器可以放在卡槽使用（有磁铁吸合），也可以取下来远程遥控灯光。

1.3 灯管伸缩使用

1.3.1 伸长灯管：左手握住手柄，右手拉灯管上端的拉环，可以拉动灯管伸长，伸长的灯管拉到最长才可以亮。

1.3.2 收纳灯管：左手握住手柄，右手在拉环处下压即可收缩灯管，收缩的那截灯管会自动灭灯。

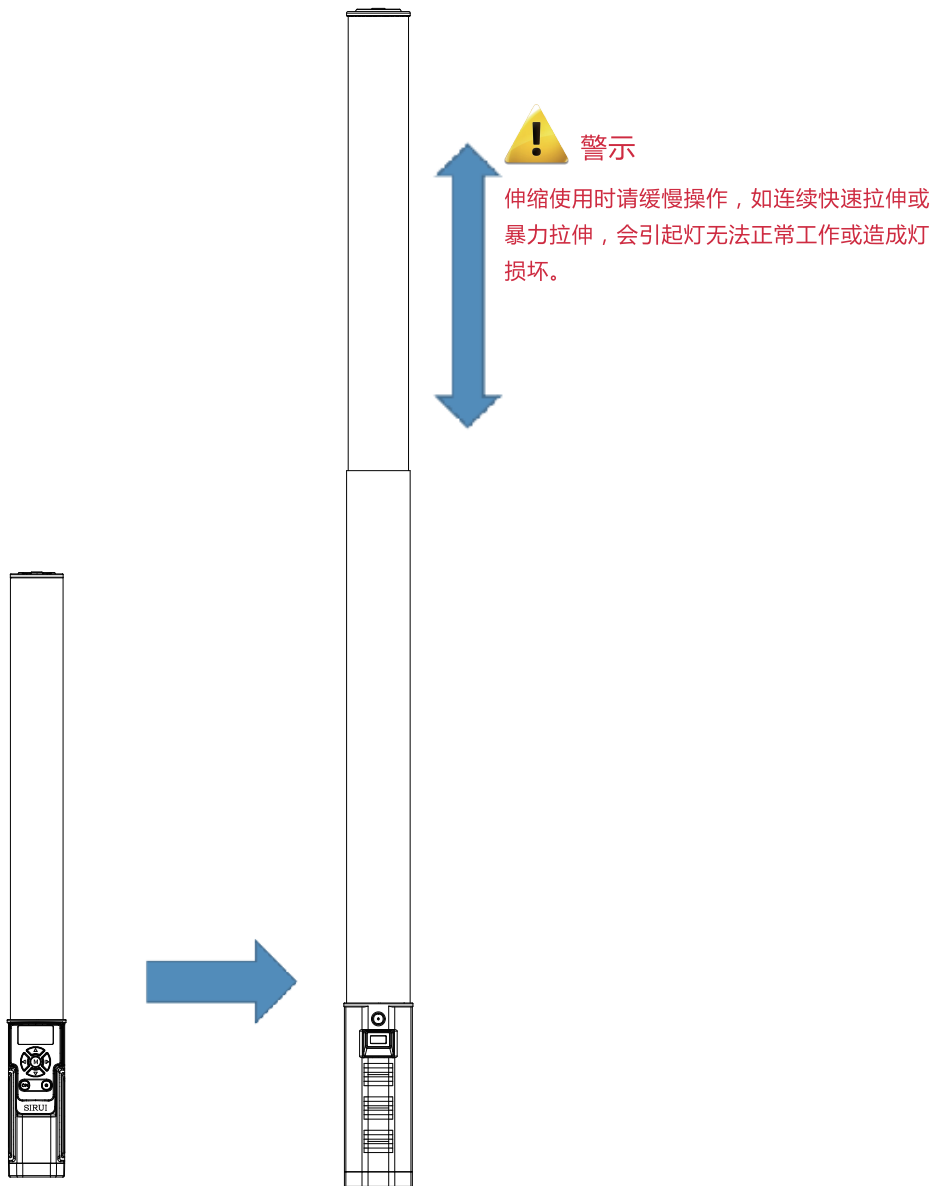

1.4 遥控器的使用

模式选择：双色温模式、彩光模式、情景特效模式

短按M模式键循环切换模式：

显示屏显示为CCT时为双色温模式

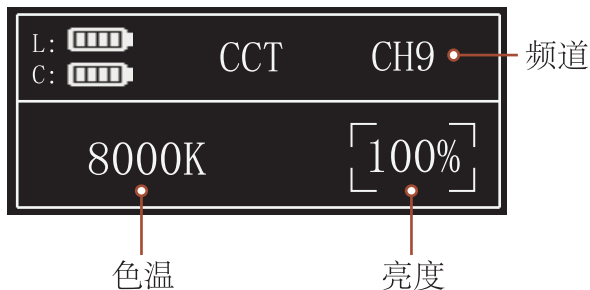

显示屏显示为H S I时为彩光模式

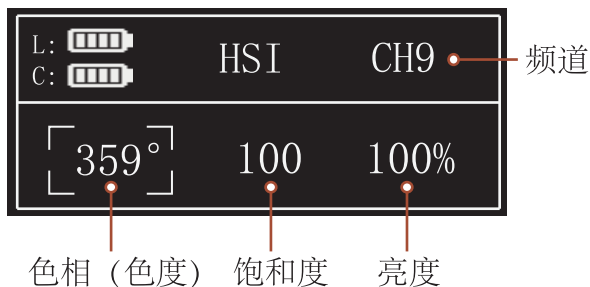

显示屏显示为FX时为情景特效模式，显示特效图标。

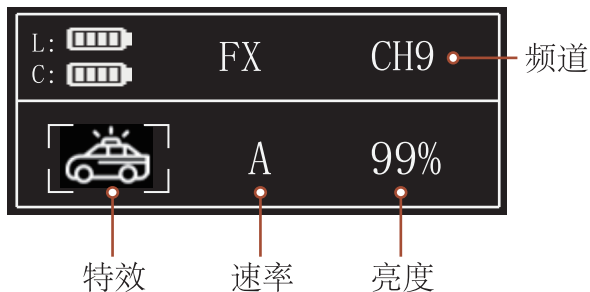

2、模式说明

2.1、双色温模式

2.1.1 短按左/右键选择选择色温值 (CCT) /亮度值 (INT)。

2.1.2 色温调节：按上键增加色温值，按下键降低色温值，短按一次数值变动50K，长按快速调节，调节范围2500K~8000K。

2.1.3 亮度调节：按上键增加亮度值，按下键降低亮度值，短按一次数值变动1%，长按快速调节，调节范围0-100%。

2.1.4 色温值存储功能：长按M模式键2s，进入色温值存储/读取页面。



2.1.4.1 按上/下键可以选择存储/读取。

2.1.4.2 按左/右键选择存储/读取对应序号。

2.1.4.3 当选择存储时，单击M键存储（支持保存10组场景数据），存储时如果选择已有参数的序号会覆盖原来存储的参数，存储完毕后会退出到CCT界面。当选择读取时，单击M键读取对应序号参数，并退出到CCT界面显示出来。

2.2、彩光模式

2.2.1 短按左/右键选择色相值 (HUE)、饱和度 (SAT)，亮度值 (INT)。

2.2.2 色相值调节：按上键增加色相值，按下键降低色相值，短按一次数值变动1°，长按快速调节，调节范围0-359°。

2.2.3 饱和度调节：按上键增加饱和度值，按下键降低饱和度值，短按一次数值变动1，长按快速调节，调节范围0-100。

2.2.4 亮度调节：按上键增加亮度值，按下键降低亮度值，短按一次数值变动1%，长按快速调节，调节范围0-100%。

2.2.5 H S I值存储功能：长按M模式键2s，进入H S I值存储/读取页面。



2.2.5.1 按上/下键可以选择存储/读取。

2.2.5.2 按左/右键选择存储/读取对应序号。

2.2.5.3 当选择存储时，单击M键存储（支持保存10组场景数据），存储时如果选择已有参数的序号会覆盖原来存储的参数，存储完毕后会退出到H S I界面。当选择读取时，单击M键读取对应序号参数，并退出到H S I面显示出来。

2.3、情景特效模式

2.3.1 短按左/右键选择特效（EFFECT）、档位调节（PRES），亮度值（INT）。

2.3.2特效选择：按上/下键选择14种特效。

2.3.3 档位调节：按上/下键调节档位，有A、B、C三挡。

2.3.4 亮度调节：按上键增加亮度值，按下键降低亮度值，短按一次数值变动1%，长按快速调节，调节范围0-100%。

2.3.5 情景特效模式有14类，用户可以根据需求选择：

序号	显示	场景	显示A	显示B	显示C
1		RGB循环	慢速	中速	快速
2		闪光灯	闪光	发布会	狗仔队
3		迪斯科	生日会	KTV	迪斯科
4		闪电	间歇	频繁	持续
5		故障灯	间歇	频繁	持续
6		电视荧幕	慢速	中速	快速
7		蜡烛	间歇	频繁	持续
8		火焰	柴火	篝火	火灾
9		烟花	短暂	连续	演出
10		警车	暴闪	频闪	快闪
11		消防车	暴闪	频闪	快闪
12		救护车	暴闪	频闪	快闪
13		音乐	音乐1	音乐2	
14	SOS	SOS			

2.4、设置频道

2.4.1、将遥控器插入摄影灯卡槽，摄影灯会自动与遥控器同步频道。

2.4.2、短按CH键，遥控器切换到您所需要的频道，当您取下遥控器时摄影灯保留与遥控器一致的频道。假设此时遥控器切换频道至CH5，取下遥控器后摄影灯的频道将是CH5。只能遥控器插入摄影灯卡槽才可以切换摄影灯的频道。

2.4.3、如果您购买多台此型号的摄影灯，可以分组控制亮度与开关，最多10组（10个频道，每个频道最多控制255台设备）。

2.4.4 遥控器液晶显示有CH0-9的数字，每个数字则对应相应的频道，通过CH按钮来切换频道。

3、电量显示

3.1 打开灯电源开关和打开遥控器的开关后，将遥控器插入摄影灯卡槽（此时摄影灯会给遥控器充电直至充满），遥控器屏幕显示L的是灯的电池电量，显示C的是遥控器的电池电量；（注意：遥控器放卡槽时，必须打开灯电源开关才能给遥控器充电！）

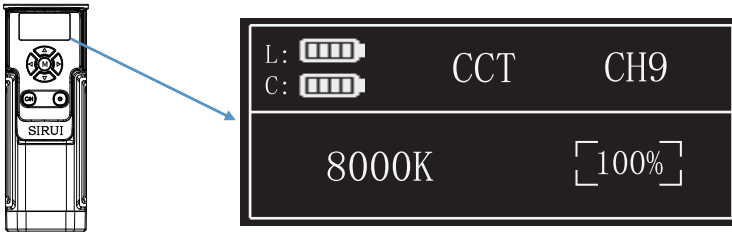

遥控器关机状态充电时显示如：



3.2 拿开遥控器后，遥控器屏幕只显示C，即遥控器本身的电量。

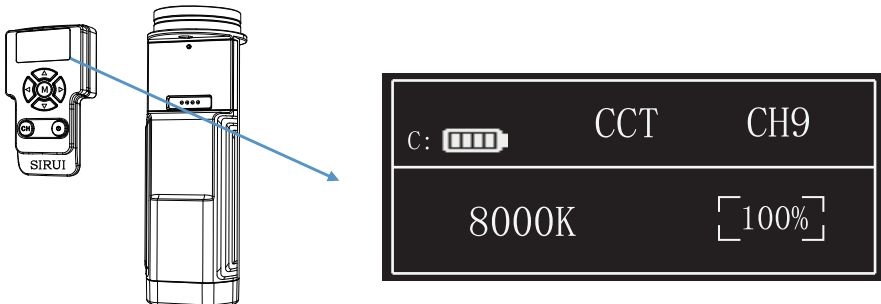

4、连接手机 APP

扫描二维码即可下载“SIRUI Light”手机APP



具体操作请参考手机APP使用说明。

5、安装和固定

根据您的需要可以通过以下方式固定摄影灯
直接固定在三脚架上使用

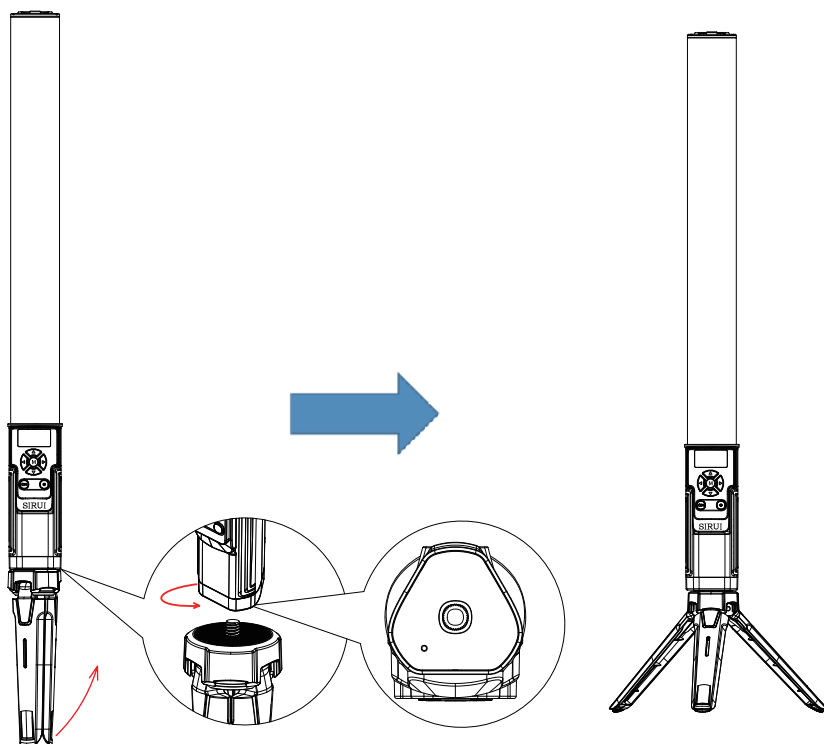

产品参数

型号	T60
产品尺寸	收缩：φ42*455mm；展开：φ42*740mm
产品重量	约658g
内置锂电池	3*2600mAh 3.7V
专用适配器	12.6V 2A
充电时间	1.5H
充电接口	DC口
功率	最大20W
色温范围	2500K~8000K
色域范围	0-359°
特效模式	14类
光照度	0.5m最大1000lux
光照距离	3-5m
TLCI	最大97
CRI	最大97
调光范围	0%-100%
最大亮度续航时间	2H
工作环境温度	-10℃-45℃
控制方式	2.4G无线遥控/手机APP
蓝牙无线控制距离	15m
遥控器距离	15m
频道	10个

设计和规格如有变更，恕不另行通知。

电池使用和注意事项

- 1、本品采用2600mAh锂电池，内置在产品里面不可拆卸，使用寿命长。
- 2、安全可靠，内置电路有过充保护、过放保护、过流保护、短路保护。
- 3、使用专用适配器充电，充电时电源适配器显示红灯变为绿灯表示充满。支持边充电使用。

注意事项

- 1、充电不要放置超过24小时。
- 2、应放置于凉爽、干燥、通风对的地方存储。
- 3、不要靠近和放置于火中。
- 4、长期不使用，请充电至70%再放置。
- 5、为了延长电池使用寿命，建议每三个月进行一次充电保养。
- 6、电池有一定的寿命限制，使用一定时间后，性能会减弱，属于正常现象。
- 7、本品使用报废后，电池请按当地的规定处理。
- 8、请使用配套适配器进行充电，其他规格有可能导致硬件损坏。如使用其他电源适配器造成的产品故障，不予保修

维护保养

- 1、灯体在工作时，如发现异常，应立即关掉电源，查明原因。
- 2、灯体应避免震动，平时注意表面除尘。
- 3、灯体稍有发热为正常现象。
- 4、维修由本厂维修部负责。
- 5、本产品保修一年，消耗品不在一年保修范围内，内置电池保修六个月。
- 6、经发现，擅自检修此灯的，将取消一年保修期，维修需要收取相关费用。
- 7、如果本品出现故障或者被水淋湿，在专业人员维修后方可继续使用。
- 8、设计和规格如有变更，恕不另行通知。

- 1、本产品不能防水，在雨天及潮湿环境下请注意防水。
- 2、请保持干燥，请勿用湿手接触产品，亦不可将产品浸入水中或暴露于雨中。
- 3、请勿在化学品、可燃性气体或其它特殊物质附件使用灯，有可能导致火灾或者电磁干扰。在这些场合下，请注意相关警告标示。
- 4、内置锂电池、禁止拆卸、撞击、挤压或投入火中，若出现严重鼓胀，请勿继续使用。
- 5、请勿放置在超过50°C的高温环境中，否则可能导致电池性能下降或损坏。使用产品要求参数的适配器进行充电，并且正确的按照操作说明，在规定的电压、温度范围内使用。
- 6、设备运行时请不要近距离直视灯光光线。

Global Distributor Directory



Products Info



Official Website

News and Tutorials



YouTube

Services



Facebook

Thank you for purchasing SIRUI products! SIRUI will provide free warranty service if the product fails due to poor materials and workmanship under normal use.

The global agents are ranked in no particular order. If after-sales service is required, please contact the local agent first.

Headquarter of SIRUI Optical Co., Ltd.

After-Sale Service Hotline: 400 830 2299

Complaints Hotline: 181 6563 9388

Singapore/T K Foto Technic Pte Ltd

Address: Funan 107 North Bridge Rd #03-09 Singapore 179105

Tel: +65 6904 6610 **Fax:**+65 6904 6620

http: //www.tkfoto.com.sg **E-mail:** ark@tkfoto.com.sg

India/Foto centre Trading Pvt. Ltd

Address: Foto Centre Trading Pvt.Ltd* 303, 3rd Floor, Ravi Building, 189-191, Dr. D. N. Road, Mumbai-400 001.Maharashtra,India **Tel:** 0091-9820110120

http: //www.sirui.in **E-mail:** info@sirui.in

Canada/LightPro Group Inc

Address: 3206 Wharton Way Mississauga, ON L4X 2C1

Toll Free: 1-800-361-9682 **Tel:** 905-940-9262

http: //www.lightprogroup.com **E-mail:** Sales@lightprogroup.com

Kazakhstan/PSP Digital

Address: г. Алматы, проспект Абая 130 (территория ЖК «Абая 130»)

Tel: 8 707 217 03 99 8 707 958 54 94

http: //pspdf.kz/contacts **E-mail:** pspkz@mail.ru

Russia /REQUIRED, LLC

Address:

Tel: 8 (499) 500-96-27

http: //kremlinstore.ru **E-mail:** order@kremlinstore.ru

Romania/West Buy S.R.L

Address: Bdul. Mircea Voda nr. 36, Sector 3, Bucharest, Romania, 030688
Telephone: +(4)021.3205652 **Tel/Fax:** +(4)021.3205655 **Mobile:** +(4)0745414956
Mobile: +(4)0752111704 **Mobile:** +(4)0756111947 **Mobile:** +(4)0752110439
http: //www.westbuy.ro **E-mail:** westbuy1@gmail.com

Slovenia/Infocona d.o.o

Address: Prevale 9, 1236 Trzin
Tel: 01/ 562 00 61 **http:** // **E-mail:** info@infocona.si

Turkey/siruturkiye

Address: Çobançesme Mah. Sanayi Cad. Kimiz Sk. No:12 Yenibosna Bahçelievler, Istanbul
Tel: 0(850)222 37 73
http: //www.siruturkiye.com **E-mail:** oceltikci@essegrup.com

Hong Kong/HONG KONG RUIJIE TRADING COMPANY LIMITED

Address: UNIT C 15/F HUA CHIAO COMM CTR 678 NATHAN RD MONGKOK KL
Tel: 00852-9409 5241
http: // **E-mail:** paulli34@foxmail.com

South Africa/Sunshine Distribution PTY LTD

Address: 29 Keyes Avenue, Rosebank Johannesburg, 2196, South Africa
Mobile: +27 79 641 0288 **Phone:** +27 11 268 0803
http: //www.sunshineco.co.za **E-mail:** Willem@sunshineco.co.za

Israel/Argol LTD

Address: 19 Hamerkava st.Holon 5885113 Israel
Tel: +972-3-5581901-6 **Fax:** +972-3-5501148
http: //www.argol.co.il **E-mail:** eli@argol.co.il

Malaysia/Leomax (M) Sdn Bhd

Address: B-5-7, block B, Pusan komersial southgate Jln dua, off jln Chan sow Lin 55200 Kuala Lumpur, Malaysia **Tel:** (+603)9224 2001
http: //www.leomax.com.my **E-mail:** account@leomax.com.my

Panama /TODO FOTO PANAMA

Address: Avenida Justo Arosemena y Cl. 45 Este,Panamá Ciudad de Panamá
Tel: 225-4620 / 203-1288
http: //www.todofotopanama.com **E-mail:** rosa@todofotopanama.com

Nigeria/Nextgen Media Ltd

Address: 73, Allen Avenue, Ikeja, Lagos
M. +234 (0) 805 1987 394 | +234 (0) 909 1094 565
http: //www.nextgentv.tv **E-mail:** Afolasade.OK@nextgentv.tv

Ukraine/BIGggSALE.com

Address: Ровно: ул. Данила Галицького 19, 718 офіс. (Главный офіс)
Tel: (096)308-36-00;(063)308-36-00;(066)308-36-00
http: //BIGggSALE.com **E-mail:** shop@bigggsale.com

Luxembourg /TSE Imaging BV

Address: Argonweg 135, 1362 AD Almere,
Tel: +31 (0) 36 8450348
http: //www.tseportal.nl **E-mail:** service@tokina.eu

Belgium/TSE Imaging BV

Address: Argonweg 135, 1362 AD Almere,
Tel: +31 (0) 36 8450348
http: //www.tseportal.nl **E-mail:** service@tokina.eu

Italy /TOSCANA FOTO SERVICE S.r.l.

Address: Via Ponte all' Asse, 2/4, 50019 Sesto Fiorentino (FI)
Tel:
http: //www.sirui-italia.it **E-mail:** info@fotocomm.it

Poland/Focus Nordic

Address: Al. Jerozolimskie 180, 02-486 Warszawa
Tel: +48 697 991 248
http: //www.focusnordic.pl **E-mail:** info@focusnordic.pl

Taiwan/Tai Nein Company Ltd.

Address: 2F, No.29, Ren Ai Road, Sec 2, Taipei, Taiwan

Tel: +886-2-33433966 **Fax:** +886-2-33433969

http: //www.lf99.com **E-mail:** tainein@ms23.hinet.net

Thailand/ 456 Marketing Company Ltd

Address: 636/12 Soi Ramkhamhaeng 39 (Thepleela1), Wangthonglang, Bangkok 10310, Thailand. **Tel:** (+662)934-6565

http: //www.456mkt.com **E-mail:** online@456mkt.com

Japan/常盤写真用品株式会社

Address: 〒460-0011 名古屋市中区大須4丁目3番43号

Tel: 052-251-0351 **Fax:** 052-251-0981

http: //www.sirui-japan.com **E-mail:** takahashi@tokiwasyashin.co.jp

New Zealand/Photogear

Address: (1) 3/2 Tawa Drive, Rosedale, Auckland (2) 49 Mackelvie Street, Ponsonby, Auckland

Tel: (+64) 9 4792886

http: //www.photogear.co.nz **E-mail:** support@photogear.co.nz

Slovakia/Focus Nordic AB

Address: KUTA centrum, Zelený pruh 95/97, 140 00 Praha 4, Česká Republika

Tel: +420 604 582 550

http: //www.focusnordic.sk **E-mail:** info@focusnordic.sk

Czech Republic/Focus Nordic

Address: Zeleny pruh 95/97, 140 00 Praha 4

Tel: +46 31 336 23 00

http: //www.focusnordic.cz **E-mail:** info@focusnordic.cz

Netherlands/TSE Imaging BV

Address: Argonweg 135, 1362 AD Almere,

Tel: +31 (0) 36 8450348

http: //www.tseportal.nl **E-mail:** service@tokina.eu

Estonia/Focus Nordic

Address:

Tel: +46 31 336 23 00

http: //www.focusnordic.ee **E-mail:** info@focusnordic.ee

Vietnam (Hanoi)/SÔNG HỒNG CAMERA

Address: SÔNG HỒNG CAMERA - 44 TRĂNG THI, HOÀN KIẾM, HÀ NỘI

Tel: Hotline CH: 098.888.2533 - 024.3938.2267

http: //www.songhongcamera.com **E-mail:** banhang@songhongcamera.com

Vietnam (Ho Chi Minh)/Rawshop.vn

Address: 61 Đường Núi Thành, Phường 13, Tân Bình, Thành phố Hồ Chí Minh, Vietnam

Tel: 00842862656999

http: //rawshop.vn **E-mail:** thanhnam79@gmail.com

Saudi Arabia/Cameramix

Address: Al-Manar, Jeddah 23462 Saudi Arabia

Tel: 00966126282444

http: //cameramix.com **E-mail:** sales@cameramix.com

“ريمدع نب بيهو” Al-Manar,
Jeddah 23462 Saudi Arabia

Republic of Korea/ Daekwang Enterprise

Address: Namdaemunno 10, Jung-gu, Seoul, South Korea (zip: 04528)

Tel: (+82) 2-752-3304

http: //www.sirui.co.kr **E-mail:** daekwangas@gmail.com

Australia/ DISCOUNT DIGITAL PTY LTD

Address: Suite1,64 Alexander St, crows Nest NSW2065, Australia

Tel: (+61)408 660 083

http: //www.pixelone.com.au **E-mail:** sales@pixelone.com.au

Indonesia/ Focus Nusantara

Address: Jln.Tanah Abang II No 77 Jakarta Pusat -10160, Indonesia

Tel: (+62)21 380 8080

http: //focusnusantara.com **E-mail:** saiful@focusnusantara.com

Republic of Lithuania /Focus Nordic

Address: Vienibas Avenue 109, LV-1058 Riga Latvia

Tel: +37 06 12 86 120

http: //www.focusnordic.lt **E-mail:** info@focusnordic.lt

Sweden/Focus Nordic AB

Address: Bergsjödalen 48, 41568 Gothenburg

Tel: +46 31 336 23 00

http: //www.focusnordic.com **E-mail:** info@focusnordic.se

Norway/Focus Nordic

Address: Ringeriksveien 164, 1339 Vøyenenga

Tel: +47 67 17 37 00

http: //www.focusnordic.no **E-mail:** info@focusnordic.no

Finland/Focus Nordic

Address: Knitter Business Park, Kutojantie 6-8, FI-02630 Espoo

Tel: +35 89 42 83 41 01

http: //www.focusnordic.fi **E-mail:** info@focusnordic.fi

Denmark/Focus Nordic

Address: Erhvervsvej 30, DK-2610 Rodovre

Tel: +46 31 336 23 00

http: //www.focusnordic.dk **E-mail:** info@focusnordic.dk

Iceland/Focus Nordic

Address:

Tel: +46 31 336 23 00

http: //www.focusnordic.is **E-mail:** info@focusnordic.is

Latvia /Focus Nordic

Address: Vienibas Avenue 109, LV-1058 Riga Latvia

Tel: +46 31 336 23 00

http: //www.focusnordic.lv **E-mail:** info@focusnordic.lv

Sri Lanka/CameraLK Store

Address: CameraLK Colombo: 263, Highlevel Road Colombo 05 00500 - Western

CameraLK Majestic City: No 28, 3rd Floor Majestic City Colombo 04 00400 - Western

CameraLK Kandy: 127A 1/1 D S Senanayake Veediya Kandy 20000 - Central Province
0812233872

Tel: +(94) 117 817 870

http: //www.cameralk.com **E-mail:** ushitha@cameralk.com

Kenya/Cameras Africa

Address: Nairobi along Kenyatta Avenue, next to Phoenix House. 1 Min Walk from Sentrim 680
Hotel

Tel: 00254722764900

http: //www.camerasafrica.com **E-mail:** sales@camerasafrica.com



Garantie
Warranty
Garantía
Garanzia



SIRUI Professional Photographic Equipment

Product	Warranty length	Produkt	Garantie Zeitraum
Tripods / Monopods / Heads / Accessories	6 years	Stative / Köpfe / Zubehör	6 Jahre
Humidity Control Cabinet (only Cabinet)	6 years	Humidor Schränke (nur Schränke)	6 Jahre
Humidity Control Cabinet (Electronics)	3 years	Humidor Schränke (elektronisch)	3 Jahre
Filters / Smartphonetools / Electronic Devices	2 years	Filter / Smartphonezubehör / Elektronische Geräte	2 Jahre

Model, Modell, Modèle, Modelo

Date, Datum, Fecha, Data

Dealer, Händler, Marchand, Comerciante, Negociante

European Service Center:

SIRUI Optical GmbH • Ernst-Augustin-Str. 1a • 12489 Berlin • Germany
Phone: +49 30 991 94 94 00
Email Address : info@siruioptical.eu

Deutsch

Die SIRUI Optical GmbH, Ernst-Augustin-Str. 1a, 12489 Berlin, gewährt Käufern eine Garantie von 6 Jahren ab Kaufdatum auf die Freiheit von Herstellungs- und Materialfehlern dieses Produkts. Von dieser Garantie nicht erfasst sind Schäden durch mechanische Beeinträchtigungen, große Hitze, nicht bestimmungsgemäße Verwendung sowie Abhandenkommen. Diese Garantie gilt nur in Verbindung mit dieser Garantiekarte und einem in Europa ausgestellten Kaufbeleg. Die gesetzlichen Rechte – insbesondere die gesetzlichen Gewährleistungsrechte – bleiben hiervon unberührt. Im Garantiefall wenden Sie sich bitte an das umseitig genannte Servicecenter.

English

SIRUI Optical GmbH, Ernst-Augustin-Str. 1a, 12489 Berlin, guarantees purchasers that this product will remain free from manufacturing and workmanship defects for 6 years from the date of purchase. Damage caused by mechanical damage, excessive heat, improper use and loss are not covered by this warranty. This warranty is valid only in connection with this warranty card and a receipt issued in Europe. Statutory rights – in particular the statutory warranty rights – remain unaffected. In the event of a warranty claim please contact the service centre listed overleaf.

Français

La société SIRUI Optical GmbH, Ernst-Augustin-Str. 1a, 12489 Berlin, Allemagne, offre aux acheteurs une garantie de 6 ans, à compter de la date d'achat, contre tous défauts de fabrication ou de matériaux. Cette garantie ne couvre pas les dommages causés par des problèmes mécaniques, la chaleur excessive, l'utilisation abusive et la perte. La garantie est uniquement valable si associée à la présente carte de garantie et une preuve d'achat délivrée en Europe. Les droits légaux – en particulier les droits de garantie prévus par la loi – restent inchangés. En cas de recours à la garantie, veuillez vous adresser au centre de service mentionné au recto.

Italiano

La SIRUI Optical GmbH, Ernst-Augustin-Str. 1a, 12489 Berlin, offre agli acquirenti una garanzia di esenzione da difetti di fabbrica e di lavorazione di questo prodotto, della durata 6 anni dalla data di acquisto. Tale garanzia non copre alcun danno causato da guasto meccanico, calore eccessivo, uso improprio nonché perdita. La garanzia è valida solo se accompagnata dalla presente scheda di garanzia e ad una prova di acquisto rilasciata in Europa. I diritti legali - in particolare, i diritti di garanzia previsti dalla legge - rimangono inalterati. In caso di intervento in garanzia, si raccomanda di rivolgersi al centro di assistenza indicato sul retro.

Español

La sociedad SIRUI Optical GmbH, Ernst-Augustin-Str. 1a, 12489 Berlin, otorga a sus compradores una garantía de 6 años a partir de la fecha de compra por los vicios ocultos y defectos de fabricación de este producto. La garantía no cubrirá los daños ocasionados por desgastes mecánicos, altas temperaturas, un uso no conforme con lo prescrito o por pérdida o extravío, y sólo será válida presentando esta carta de garantía y el comprobante de compra expedido en Europa. Lo anterior no afectará a los derechos legales y, en particular, a los derechos de garantía legales. En el caso contemplado en la garantía, le rogamos se ponga en contacto con el Centro de atención al cliente, cuya dirección consta en el dorso de esta carta de garantía.

Portugués

A SIRUI Optical GmbH, Ernst-Augustin-Str. 1a, 12489 Berlin, garante aos seus clientes uma garantia de 6 anos a partir da data de aquisição relativa à liberdade de defeitos de produção e fabrico do produto. Esta garantia não cobre danos causados por efeitos adversos decorrentes de avaria mecânica, calor excessivo, utilização indevida, ou perda. Esta garantia é apenas válida mediante apresentação deste cartão de garantia e um recibo emitido na Europa, sem prejuízo dos direitos legais (em particular, os direitos legais de garantia). Em caso de reclamação, contate o centro de serviço referido no verso.

SIRUI Warranty

Professional Photographic Equipment



SIRUI USA, LLC

For technical support, service or repairs please contact:
29 Commerce Court Verona, NJ 07044
info@sirui.com Phone: 866-373-0829

Thank you for your purchase of Sirui professional products! Sirui warrants that your purchase is free from defects in materials and workmanship, under normal use during the Limited Warranty period. The warranty period starts on the original date of purchase on your sales receipt. If service is required, please include a copy of the sales receipt and this warranty card, with an explanation of the problem. Please store your sales receipt and warranty card in a safe location.

Product	Warranty period
Tripods and Heads	6 years
Optical and Smart Products	1 year (Battery: 6 months)
Humidity Control Cabinets	6 year (Electronic components: 3 years)

Model purchased : _____

Date : _____

Store : _____

Serial number : _____

Sirui USA Limited Warranty

This warranty is limited to the repair, adjustment and/or replacement, at Sirui or its authorized distributor's option, of defective parts, free of charge (except the cost of transportation to the distributor/service center). Responsibility is limited to actual cost of item.

Register online at www.sirui.com. Call or email with questions or problems, before sending product in for repair. For warranty service on product purchased in the USA, all shipping and insurance charges must be prepaid. Include a copy of the sales receipt, this warranty card and an explanation of the problem. The product or defective part(s) may be sent through a local authorized SIRUI USA dealer or directly to the SIRUI USA distributor/service center indicated on this warranty card. Sirui will not be responsible for expenses or inconveniences, or consequential damages to equipment, or by breach of any expressed or implied warranty.

Out-of-warranty repairs - An estimate (including shipping costs) will be provided by the SIRUI USA distributor/service center indicated on this warranty card and repairs will begin once the estimate is approved and payment is received. A return shipping fee will be charged for refused estimates.

Limitations

Warranty is non-transferable. This warranty covers all defects encountered in normal use of the equipment and does not apply in the following cases:

- 1) If the equipment has been serviced by other than an authorized Sirui distributor or service center.
- 2) Damage to the equipment due to modification, overloading, mishandling, abuse, accident, sand, corrosives, water damage or not following operating instructions.
- 3) No valid proof of purchase is provided.
- 4) Damage caused by acts of nature (including, but, not limited to fires, floods or earthquakes).

This warranty is only valid when product is purchased from an authorized SIRUI USA dealer.

Please visit SIRUI's USA official website or consult the local dealer for the Return and Exchange Policy.